

ATN OTS-14

THERMAL IMAGING SYSTEM



OPERATOR'S MANUAL (OTS-14-003) REVISION 3 - NOVEMBER 2010

operator's manual

Important Export Restrictions! Commodities, products, technologies and services contained in this manual are subject to one or more of the export control laws and regulations of the U.S. Government and they fall under the control jurisdiction of either the US Department of State or the US BIS-Department of Commerce. It is unlawful and strictly prohibited to export, or attempt to export or otherwise transfer or sell any hardware or technical data or furnish any service to any foreign person, whether abroad or in the United States, for which a license or written approval of the U.S. Government is required, without first obtaining the required license or written approval from the Department of the U.S. Government having jurisdiction. Diversion contrary to U.S. law is prohibited.



**AMERICAN
TECHNOLOGIES
NETWORK
CORP.**

The information in this manual furnished for information use only, is subject to change without notice, is not to be construed as a commitment by ATN Corp. ATN Corp. assumes no responsibility or liability for any errors or inaccuracies that may appear in this book.

© 2010 ATN Corp. All right reserved.

SAFETY SUMMARY

STUDY CAREFULLY THIS MANUAL BEFORE TURNING ON AND OPERATING THIS PRODUCT.

CAUTIONS

The ATN OTS-14 thermal imaging systems are precision optical-electronic instruments and requires careful handling. To provide safe use of the systems the following instructions should be observed:

- Do not dismantle the device.
- Keep the device clean; protect it from moisture, sharp temperature drops and shocks.
- Be careful not to touch the glass surfaces. If you put fingerprints on, or contaminate the glass surfaces, use only clean and soft materials to clean it.
- Do not leave the device in on position during stops in operation.
- Remove the battery from the device for the period of storage.

CAUTION:

**THIS PRODUCT CONTAINS NATURAL RUBBER LATEX WHICH
MAY CAUSE ALLERGIC REACTIONS**

WARNING

Do not permanently attach the camera to dynamic-mount applications that continuously transmit vibration (such as on vehicles or heavy machinery).

WARNING

Do not point the camera directly at any high-intensity objects that you must not view with your eyes (such as the sun or a welding arc). If you do, you will damage the camera.

WARNING

Operating OTS outside of its specified operating temperature range or voltage range can cause permanent damage and will void the warranty.

WARNING

Use the power button to turn the camera off before you remove power (remove batteries or disconnect external power supply).

WARNING

OTS operates over a wide operating temperature range (-20°C to +50°C). Not all AA batteries are specified over this same temperature span. Check the manufacturer's specifications of your selected battery to verify the valid temperature range.

WARNING

Do not use any battery other than a CR-123A lithium battery. DO NOT use any battery(ies) providing a (combined) voltage greater than 3.0 volts.

WARNING

Do not install batteries of different types (lithium with lithium-ion rechargeable). All batteries must be of the same type.

WARNING

Always replace ALL 2 batteries. If you install new batteries with used batteries, the result may be dangerous.

WARNING

Do not replace batteries in a possibly explosive environment, such as a gas station (or any place where you must turn off your vehicle engine). If you do, sparks can cause an explosion.

WARNING

Remove the batteries before you store the camera for extended periods (2 weeks or more).

WARNING

Do not carry batteries in pockets containing metal objects such as coins, keys, etc. Metal objects can cause the batteries to short circuit and become very hot. In the case of lithium batteries, a short circuit could cause them to explode.

WARNING

Observe battery manufacturer's guidelines for safe handling and proper disposal of batteries.

EQUIPMENT LIMITATIONS

- The OTS detector spectral band (7 to 14 mkm) provides a better penetration through smoke, smog, dust, water vapor etc.
- Infrared radiation does not travel through glass and therefore the monocular does not sense objects if they are behind a glass window.

TABLE OF CONTENTS

	pg.
SECTION I. INTRODUCTION	1-1
1.1 General Information	1-2
1.1.1. Scope	1-2
1.1.2. Reports	1-2
1.1.3. Storage	1-2
1.1.4. Warranty Information	1-3
1.2. Description and Data	1-5
1.2.1. Description	1-5
1.2.2. OTS Standard Components	1-7
1.2.3. OTS Optional Components	1-9
1.2.4. Specifications	1-10
1.2.5. Mechanical Functions	1-11
1.2.6. Optical Functions	1-12
1.2.7. Electrical Functions	1-12
SECTION II. ASSEMBLY AND PREPARATION	2-1
2.1. Preparation	2-2
2.1.1. Preparation for use	2-2
2.1.2. Examination for operation	2-3
2.1.3. Setting	2-3
2.2. Assembly	2-5
2.2.1. External power source	2-5
2.2.2. Output	2-5
2.2.3. Head mount	2-6
2.2.4. Helmet mount	2-7
2.2.5. Dual Bridge Adapter	2-8
2.2.6. 2X Afocal Lens	2-9
SECTION III. OPERATION	3-1
3.1. General Information	3-2
3.1.1. General	3-2
3.1.2. Controls and Indication	3-2

3.2. Operating procedure	3-4
3.2.1. Turning On	3-4
3.2.2. Focusing	3-4
3.2.3. Color modes	3-5
3.2.4. Brightness	3-5
3.2.5. Zoom	3-6
3.2.6. Manual Image Refresh	3-6
3.2.7. Shut Down Operations	3-6
SECTION IV. MAINTENANCE INSTRUCTIONS	4-1
4.1. Preventive Maintenance Checks and Services (PMCS)	4-2
4.1.1. Purpose of PMCS	4-2
4.1.2. Frequency of Performing PMCS	4-2
4.2. Troubleshooting	4-6
4.2.1. General	4-4
4.2.2. Troubleshooting Procedures	4-4
4.3. Maintenance Procedures	4-6
4.3.1. Scope Maintenance	4-6
4.3.2. Cleaning Procedures	4-6
4.3.3. Preparing for Extended Storage	4-7
Appendix A. Spare Parts List	A-1
For Technical Information	INFO-1

SECTION I

INTRODUCTION

1.1 GENERAL INFORMATION

1.1.1. SCOPE

This manual contains instructions for use in operating and maintaining the ATN OTS-14 thermal imaging systems. Throughout this manual, the ATN OTS-14 will be referred to as the scope or OTS.

1.1.2. REPORTS

Reports from the user on recommendations for improvements are encouraged. Send reports to the address below.

American Technologies Network Corp.
1341 San Mateo Avenue
South San Francisco, CA 94080
(800) 910-2862
(650) 989-5100
(650) 875-0129 fax
info@atncorp.com
www.atncorp.com

1.1.3. STORAGE

Storage of OTS should be done in the factory packing and after a thorough PMCS as outlined in Section 4.1. of this manual. This will ensure the scope remains in mission ready condition during storage. Battery should be stored separately from the scope.

The scope should not be placed on the floor, in any area exposed to high temperatures or direct sunlight. Presence of acid and alkaline vapor, as well as of other aggressive admixtures in the air is unacceptable.

1.1.4. WARRANTY INFORMATION

ONE YEAR PRODUCT WARRANTY

This product is guaranteed to be free from manufacturing defects in material and workmanship under normal use for a period of 1 (one) years from the date of purchase. In the event a defect that is covered by the foregoing warranty occurs during the applicable period stated above, ATN, at its option, will either repair or replace the product, and such action on the part of ATN shall be the full extent of ATN's liability, and the Customer's sole and exclusive remedy. This warranty does not cover a product (a) used in other than its normal and customary manner; (b) subjected to misuse; (c) subjected to alterations, modifications or repairs by the Customer or by any party other than ATN without prior written consent of ATN; (d) special order or "close-out" merchandise or merchandise sold "as-is" by either ATN or the ATN dealer; or (e) merchandise that has been discontinued by the manufacturer and either parts or replacement units are not available due to reasons beyond the control of ATN. ATN shall not be responsible for any defects or damage that in ATN's opinion is a result from the mishandling, abuse, misuse, improper storage or improper operation, including use in conjunction with equipment which is electrically or mechanically incompatible with or of inferior quality to the product, as well as failure to maintain the environmental conditions specified by the manufacturer. This warranty is extended only to the original purchaser. Any breach of this warranty shall be waived unless the customer notifies ATN at the address noted below within the applicable warranty period.

The customer understands and agrees that except for the foregoing warranty, no other warranties written or oral, statutory, expressed or implied, including any implied warranty of merchantability or fitness for a particular purpose, shall apply to the product. All such implied warranties are hereby and expressly disclaimed.

LIMITATION OF LIABILITY

ATN will not be liable for any claims, actions, suits, proceedings, costs, expenses, damages or liabilities arising out of the use of this product. Operation and use of the product are the sole responsibility of the Customer. ATN's sole undertaking is limited to providing the products and services outlined herein in accordance with the terms and conditions of this Agreement. The provision of products sold and services performed by ATN to the Customer shall not be interpreted, construed, or regarded, either expressly or implied, as being for the benefit of or creating any obligation toward any third party of legal entity outside ATN and the Customer; ATN's obligations under this Agreement extend solely to the Customer. **ATN's liability hereunder for damages, regardless of the form or action, shall not exceed the fees or other charges paid to ATN by the customer or customer's dealer. ATN shall not, in any event, be liable for special, indirect, in-**

cidental, or consequential damages, including, but not limited to, lost income, lost revenue, or lost profit, whether such damages were foreseeable or not at the time of purchase, and whether or not such damages arise out of a breach of warranty, a breach of agreement, negligence, strict liability or any other theory of liability.

PRODUCT WARRANTY REGISTRATION

In order to validate the warranty on your product, ATN must receive a completed Product Warranty Registration Card for each unit or complete warranty registration on our website at www.atncorp.com. Please complete the included form and immediately mail it to our Service Center: ATN Corporation, 1341 San Mateo Avenue, South San Francisco, CA 94080.

OBTAINING WARRANTY SERVICE

To obtain warranty service on your unit, End-user must notify ATN service department by calling **800-910-2862** or **650-989-5100** or via e-mail service@atncorp.com to receive a Return Merchandise Authorization number (RMA). When returning please take or send the product, postage paid, with a copy of your sales receipt to our service center, ATN Corporation at the address noted above. All merchandise must be fully insured with the correct postage; ATN will not be responsible for improper postage or, missing or damaged merchandise during shipment. When sending product back, please clearly mark the RMA# on the outside of the shipping box. Please include a letter that indicates your RMA#, Name, Return Address, reason for service return, Contact information such as valid telephone numbers and/or e-mail address and proof of purchases that will help us to establish the valid start date of the warranty. **Product merchandise returns that do not have an RMA listed may be refused or a significant delay in processing may occur.** Estimated Warranty service time is 10-20 business days. End-user/customer is responsible for postage to ATN for warranty service. ATN will cover return postage/shipping after warranty repair to end-user/customer only if product is covered by aforementioned warranty. ATN will return product after warranty service by domestic UPS ground and/or domestic mail. Any other requested, required or international shipping method the postage/shipping fee will be the responsibility of the end-user/customer.

1.2. DESCRIPTION AND DATA

1.2.1. DESCRIPTION

A. PURPOSE

The ATN OTS-14 is multi-purpose thermal imaging system intended for law enforcement, military and commercial uses.

It is built around state of the art uncooled thermal imaging technology, highly integrated DSP-based electronics and a compact, light weight system. The ATN OTS thermal systems provides the excellent image quality that is unaffected by lights or shadows that seriously hamper the image quality of image intensified night vision. Total darkness, camouflage or bright lights will not affect the sensitivity of these units.

The included and optional accessories provide for the versatility of the monocular. You can put it on a headset or on a helmet, connected to another monocular to build a binocular system. The ATN OTS-14's superior performance, compact size, comfort of wear and cost efficiency makes it the perfect thermal imaging device.



Figure 1-1. ATN OTS Thermal Imaging Systems

B. FEATURES

OTS has the following important features:

- High resolution digital thermal imaging
- Compact, light weight and durable housing
- High Quality optics
- Video and computer output
- Two Image/Video modes (Black/White and Color)
- Adjustable display brightness
- Adjustable eyepiece diopter
- Adjustable lens focus
- Digital zoom
- Power input capability
- Analog video output
- USB interface
- Waterproof
- Head/helmet mountable for hands free usage

1.2.2. OTS STANDARD COMPONENTS

The OTS-14 standard components are shown in Figure 1-2 and presented in Table 1-1.



Figure 1-2. OTS-14 Standard Components

Table 1-1. OTS-14 Standard Components

ITEM	DESCRIPTION	QTY
1	Scope	1
2	Soft Carrying Case	1
3	Hard Storage Case	1
4	Lens Tissue	1
5	Lithium Battery CR123A	2
6	RCA Video/power Adapter	1
7	Operator's Manual	1
8	Neck Lanyard	1

- 1) **Scope**
The monocular thermal imaging device.
- 2) **Soft Carrying Case**
A protective bag used for storing of OTS and accessories.
- 3) **Hard Storage Case**
A protective case used for shipping/storing OTS and accessories.
- 4) **Lens Tissue**
Uses for cleaning of lenses surface.
- 5) **Lithium Battery CR123A**
Two CR123A lithium batteries used to power the unit.
- 6) **RCA Video/power adapter**
RCA Video/power adapter used for video transmission and to connect external power sources.
- 7) **Operators Manual**
Provides equipment description, use of operator controls and preventative maintenance checks and service.
- 8) **Neck Lanyard**
Used to prevent damage due to dropping the scope.

1.2.3. OTS OPTIONAL COMPONENTS

The OTS optional components are shown in Figure 1-4 and presented in Table 1-3.



Figure 1-4. OTS-14 Optional Components

Table 1-3. OTS-14 Optional Components

ITEM	DESCRIPTION	ITEM CODE
1	USB cable	
2	Headmount Assembly	ACMAN14GK
3	Flip-up Helmet Mount	ACTIOT14HMNT
4	Dual Bridge	ACTIOT14DB
5	2X Afocal Lens	ACTILENSOT2X

1) **USB Cable**

The USB Cable is an interface link between the thermal monocular and the external PC, and it accepts the external power supply at the same time.

2) **Headmount Assembly**

Adjustable universal assembly that secures the ATN OTS-14 to the operator's head providing hands free operation.

3) **Flip-up Helmet Mount**

Provides mount interface for the ATN OTS-14 to a range of ballistic helmets.

4) **Dual Bridge**

Adapter that allows the ATN OTS-14 to be attached to in a binocular configuration to the head- or helmet mount.

5) **2X Afocal Lens**

Attaches to the ATN OTS-14 for enhanced range performance.

1.2.4. SPECIFICATIONS

The following tables provide information pertaining to the operational, electrical, mechanical, optical and environmental characteristics for the sights.

Table 1-4. Specifications

ITEM	DATA
Magnification	1,8X
Objective Focal Length	25 mm
FOV	11° x 8°
Focus Range	from 1m to infinity
Focus Adjustment	Manual
Exit Pupil	14mm
Eye Relief	25mm
Detector Type	Uncooled Microbolometer
Spectral Response	7-14 μm
Pixels	160 x 120
Pixel Size	30 x 30 μm
Angular Resolution, mrad	1,2
Thermal Sensitivity	< 0,1°C

ITEM	DATA
Range to Detect a Human	475 m
Output Format	Analog PAL / NTSC
Display	Color OLED matrix
Display Format	SVGA, 852 x 600 pxl
Digital ZOOM	Fixed 2x (optional 5x)
Brightness Adjustment	Manual
Contrast Adjustment	Automatic
Available User Interfaces	From outside PC through USB interface
Power Supply	2 x 3V, 123A type
Start-Up Time	< 3 sec
Operating Time w/one battery pack	4 hrs
External Power Supply	DC 6V, 500 mA
Operating Temperature Range	from -20°C to +50°C
Waterproof	Yes, up to 10m submersion
Dimensions	118 x 81 x 52 mm
Weight (w/batteries)	0,34 kg

* ATN reserves the right to change the above specifications at any time without notice

1.2.5. MECHANICAL FUNCTION

The mechanical adjustments of the OTS sights allow for physical differences between individual operators using the system. The scope functions include the switchboard, refresh button, universal connector, eyepiece diopter adjustment ring, focusing ring, battery compartment cover, mounting rail. The mechanical controls are identified in Figure 1-4.

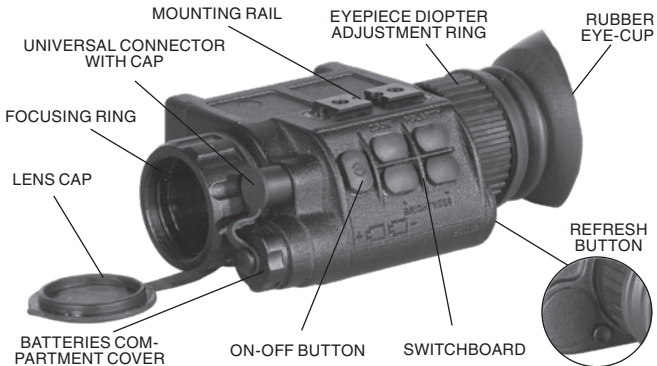

Figure 1-4. OTS Mechanical Controls

1.2.6. OPTICAL FUNCTION

The optical functions include an objective lens, thermal imaging detector and eyepiece. Infrared energy is emitted proportionally to the temperature of an object. The warmer the object, the more energy it emits. The infrared energy from the objects is focused by the optics, onto an infrared detector. The information from infrared detector is passed to electronics for image processing. The signal processing circuitry translates the infrared detector data into an image that can be viewed on the built-in OLED display. The image is observed through an eyepiece by operator.

1.2.7. ELECTRICAL FUNCTION

The electronic circuit is powered by replaceable batteries - either two 3.0 Volt lithium battery (CR123A).

OTS can be to connect to an external 6 VDC/ 1 A power supply used both the video or PC cable.

Power from the batteries or external power supply is supplied to the components through the OFF-ON switch button.

SECTION II

ASSEMBLY AND PREPARATION

2.1. PREPARATION

2.1.1. PREPARATION FOR USE

This chapter contains the information necessary to prepare the scope for operation. This includes unpacking, examination for damage, and battery installation.

A. UNPACKING

The following steps must be accomplished prior to each mission where the sight is used.

1. Open carrying case, remove the scope and check contents for completeness.
2. Inspect the scope for obvious evidence of damage to optical surfaces, body, eyecups, operation buttons, etc. Ensure that all optical surfaces are clean and ready for use. Clean with lens paper.

B. ATTACHMENT OF NECK LANYARD

To prevent damage due to dropping the scope, use the neck lanyard included with your equipment.

C. INSTALLATION OF BATTERY

WARNING

The lithium battery contains sulfur dioxide gas under pressure.

Do not heat, puncture, disassemble, short circuit, attempt to recharge or otherwise tamper with the batteries.

Turn off equipment if battery compartment becomes unduly hot. If possible, wait until the batteries have cooled before removing them.

If you inhale sulfur dioxide, seek medical attention.

The OTS will operate with two CR123A Lithium battery type.

CAUTION

Make certain the operation switch is in the OFF position before installing batteries.

Install CR123A Lithium batteries as follows.

1. Remove the battery cap by turning it counterclockwise.
2. Check to ensure the o-ring is present. If not, replace it.
3. Observe polarity, as indicated on the outside of the battery compartment, and insert two 3.0 Volt CR123A Lithium battery into the battery compartment, minus (-) end first (Figure 2-1).
4. Replace battery cap by pushing and turning it clockwise. Tighten it firmly to ensure a watertight seal.



Figure 2-1. Install batteries

2.1.2. EXAMINATION FOR OPERATION

Before getting started make sure to follow these steps:

1. Push ON-OFF button on the scopel.
2. Make sure that the luminance in ocular is present.
3. Observe the scene, and adjust the diopter and/or lens for optimal image clarity.

2.1.3. SETTING

The working settings of OTS may be customized by means of a Graphical User Interface (GUI) installed onto PC.

The Graphical User Interface (GUI) allows user to alter the behavior of the device that includes defining the temperature based coloriza-

tion parameters, configuring the device by defining which functions are enabled or disabled, switching crosshair marks and defining magnification parameters. The device settings can be modified in realtime operation mode to simplify tailoring to your needs and then saved to the device (see detail in OTS GUI Manual Guide).

Install the software into the PC from the CD/DVD supplied in the package of each OTS. The USB Cable(1) is an interface link between the thermal monocular and the external PC, and it accepts the external power supply (2) at the same time (Figure 2-2).

IMPORTANT: When the unit is to be powered with external sources, first make sure the batteries have been taken out.

Connect the monocular to a PC and to an external power supply as follows:

1. Remove the batteries.
2. Remove the protective cap from the monocular output connector socket.
3. Attach the PC cable to the output connector socket.
4. Attach the USB plug of the cable to a computer USB port.
5. Attach the power jack socket of the cable to a 6 VDC/ 1 A power supply.



Figure 2-2. OTS with USB Cable

Switch the monocular on, start the auxiliary software and introduce all the needed or desirable settings into it. Use the software as provided by the software manual.

2.2. ASSEMBLY

2.2.1. EXTERNAL POWER SOURCE

WARNING

When the unit is to be powered with external sources, first make sure the batteries have been taken out.

As an external power source, a standard network controller with outer voltage of 6V and current of over 0.5A can be applied. To connect an external source recommend to use a 6mm standard double-pole socket in the way the positive contact is the central contact.

Use both the video or PC cable to connect an external 6 VDC/ 1 A power supply to the OTS.

Connect an external power supply to the monocular as follows:

1. Remove the batteries.
2. Remove the protective cap from the monocular output connector socket.
3. Attach the video/PC cable to the output connector socket.
4. Attach the power jack socket of the cable to a 6 VDC/ 1 A power supply.

NOTES

1. The external power supply plug must have a 6 mm OD contact with center pin positive.
2. Avoid a sudden removal of power source: use the power button «ON/OFF» to turn the monocular off before you remove batteries or disconnect external power supply.
3. Replace the protective cap on the monocular output connector socket after disconnecting the cable.

2.2.2. VIDEO OUTPUT

The OTS incorporates a sealed Connector used for video transmission and to connect external power sources. Video Cable attaches the scope to the video facilities for video recording or video

transmission (1) to the external display, though at the same time it accepts the external power supply(2).

Connect the monocular to an external video display/recorder and to an external power supply as follows:

1. Remove the batteries.
2. Remove the protective cap from the connector socket.
3. Attach the video cable to the OTS output connector socket.
4. Attach the RCA plug of the video cable to a compatible jack on an external video display/recorder, or extension cable.
5. Attach the power jack socket of the cable to a 6 VDC/ 1 A power supply.

WARNING

When the unit is to be powered with external sources, first make sure the batteries have been taken out.



Figure 2-3. Attaching Video Cable

2.2.3. HEAD MOUNT

The operator can mount the monocular onto the head bracket using any of two Mounting Rail located on the opposite sides of the body, to be able to see through the eyepiece with his/her right or left eye correspondingly.

To mount the OTS-14 to a headmount, perform the following:

1. Loosen the screw (1). Push the button (2) and insert the rail of the OTS-14 into the socket (3) of the headset.

2. Place the headmount with OTS-14 onto a head.
3. Loosen the screw (1) and move the unit along the rail for eye relief adjustment.
4. The OTS-14 headmount has a flip-up mechanism. Push the button (4) on the side of mount and lift the unit up until the unit fixates in the top position.
5. Push the same button (4) to lower OTS-14 to the viewing position.
6. The OTS-14 can be placed onto the right or left eye. In order to readjust the monocular for use with the other eye, take the unit off the adapter, turn the unit to other side (for 180°) and mount it on the headmount adapter through the rail on this side. Push the button (5) and move the device along the slide-rail (6) for comfortable position.

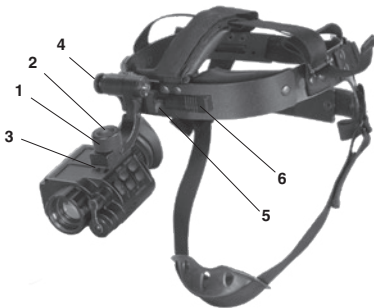

Figure 2-4. Attaching OTS to Head Mount

2.2.4. HELMET MOUNT

Attachment of OTS to a standard PASGT helmet. The helmet mount fits securely onto helmet via a rugged strapping device and grooved hooks. With helmet mount, the OTS can be positioned directly in front of user's eyes or flipped up out of viewing position.

1. Install the mount onto helmet as shown on the picture.
2. Tighten and fixate the straps (1)
3. Attach the monocular to the rail.
4. Loosen screw (3). Push button (2) and insert the bracket of the OTS into rail (4) of the helmet mount.
5. Place the helmet with OTS onto head.
6. Loosen the screw (3) and move the unit for proper eye relief adjustment.
7. The OTS helmet mount has a flip-up mechanism. Push the button (5) on the side of mount and lift the unit up until the unit fixates in the top position.
8. Push the same button (6) to lower OTS to viewing position.
9. The OTS can be placed onto the right or left eye. In order to readjust the monocular for use with the other eye, take the unit off the headmount adapter, turn the unit to other side (for 180°) and mount it on the adapter through the rail on this side. Push the button (6) and move the device along the slide-rail (6) for comfortable position.

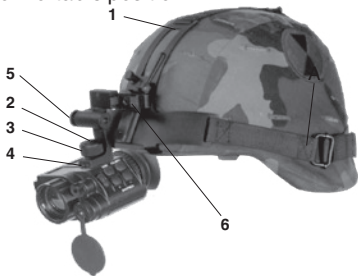

Figure 2-5. Attaching OTS to Helmet Mount

2.2.5. DUAL BRIDGE ADAPTER

The Dual Bridge Adapter is designed to connect two OTS-14 in binocular. Adapter allows also the binocular to be attached to the headmount or helmet mount.

To mount the units with Dual Bridge Adapter perform the following:

1. Align the unit and the adapter.
2. Push the clamps (2) on the front of adapter.
3. Slide the unit rearwards until the alignment boss aligns with the alignment groove (3) on the adapter. Push until the unit locks into the adapter.
4. Repeat for second unit.

For detachment the unit push the clamps on the front of adapter and slide the unit forwards.



Figure 2-6. Dual Bridge Adapter

2.2.6. 2X AFOCAL LENS

2X afocal lens is optical doubler specifically designed for thermal imaging systems. Using interchangeable connectors the lens can connect to the OTS. Focal length of the system simply increases by a factor of 2. To install 2X afocal lens screw it into the objective lens of scope. OTS 2X afocal lens is shock and vibration tested.



Figure 2-7. OTS with 2X Afocal Lens

SECTION III

OPERATION

3.1. GENERAL INFORMATION

3.1.1. GENERAL

This section contains instructions for operation of OTS. The function of controls and indicators is explained.

CAUTION

The OTS scope is a precision electron-optical instrument and must be handled carefully at all times.

3.1.2. CONTROLS AND INDICATION

The OTS scope is designed to adjust for different users and corrects for most differences. The controls for the scope are shown or described in Figure 3-1 and Tables 3-1.

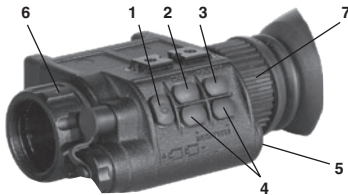

Figure 3-1. Controls

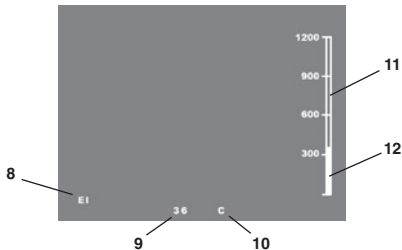

Figure 3-2. OTS Screen Indications

Table 3-1. Controls and Indication

ITEMS	CONTROLS AND INDICATORS	FUNCTIONS
1	ON-OFF Button	Controls scope power. To turn the unit on and off press the button .
2	ZOOM Button	Digital 2x magnification On.
3	POLARITY Button	Switch from black/white to color mode.
4	BRIGHTNESS Buttons	Adjustment of the output image brightness.
5	REFRESH Button	Maintain 0.5 second video in the memory of unit.
6	Objective Lens Focus	Focuses objective lens. Adjusts for sharpest image of viewed object.
7	Diopter Adjustment	Focuses eyepiece lens without the need for glasses. Adjusts for sharper image of intensifier screen.
8	EI Indicator	Automatic Electronic Iris (EI) mode indicator.
9	Temperature	Showing the actual measured temperature at the center of the display.
10	Units	Showing the units of temperature measuring.
11	Scale	Scale of the temperature indicator.
12	Bar	Dynamic temperature indicator.

3.2. OPERATING PROCEDURE

3.2.1. TURNING ON

Open the objective lens cover. The objective lens cover protects the monocular from inadvertent exposure to extremely high levels of radiant flux. Never leave the monocular with the objective lens cover off.

To turn the unit on press the button labeled ON/OFF.

After a warm-up time of approximately 3 seconds, video of the thermal scene appears.

NOTE

During the warm-up time, a logo comes into view on the monocular display. Next the thermal image replaces the logo.

NOTE

The image you see will have a yellow tint. The yellow tint provides better contrast and resolution over black and white images.

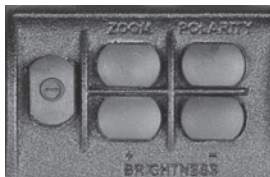

Figure 3-3. Switchboard of ATN OTS-14

3.2.2. FOCUSING

To focus the scope you need to adjust the diopter first. The scope has an adjustable eyepiece with a range of +2 to -6 diopter. Simply turn the diopter clockwise until it stops. Then concentrate on any object and slowly turn the diopter back counter clockwise until the grain in the image is sharp. Then rotate the eyecup to accommodate use over the left or right eye.

Your scope has the ability to focus either long range or short. Focus the front lens to rotate it until the image and the grain are both sharp.



Figure 3-4. Focus Adjustment

NOTE

The front lens should be readjusted for viewing objects at different distances. Rotate the focusing ring clockwise for far focus, counterclockwise for near focus.

3.2.3. COLOR MODES

«POLARITY» button switches the display/video mode from black/white to color. To reset the display to the black/white mode press POLARITY button again.

3.2.4. BRIGHTNESS

Press «BRIGHTNESS +» and «BRIGHTNESS –» buttons for brightness adjustment. Each short push of the buttons «BRIGHTNESS +» or «BRIGHTNESS –» raises or lowers the display brightness, correspondingly, in stepwise way.

NOTE

Levels 1 to 8 range from full dim to full bright.

3.2.5. ZOOM

«ZOOM» button activates a digital zoom function.

The OTS default digital zoom is 1X. When «ZOOM» button is pushed first time, the scope will display a scene magnified 2 X, according to the monocular optical magnification. To reset the magnification to the 1X press «ZOOM» button again.

NOTE

Optional 1X - 2X - 4X magnification mode can be activated by GUI.

3.2.6. MANUAL IMAGE REFRESH

Degradation of the image (image blurring) is caused by charge accumulation on the detector array.

Use the «REFRESH» button to maintain an optimum thermal image. During this refresh, the video will freeze for approximately 0.5 second.



REFRESH BUTTON

Figure 3-6. Refresh Button

NOTE

While performing very frequent refreshes can provide the best possible image quality but also can decrease substantially the battery life.

3.2.7. SHUT DOWN OPERATIONS

To finish the work, perform the following:

1. Use the ON-OFF button to turn the scope off.
2. Replace the protective cover on the objective lens.
3. Disconnect the cable (if it present).
4. Replace the protective cap on the monocular output connector socket.
5. Return the monocular and the cable to the case.

SECTION IV

MAINTENANCE INSTRUCTIONS

4.1. PREVENTIVE MAINTENANCE CHECKS AND SERVICES (PMCS)

4.1.1. PURPOSE OF PMCS

PMCS is performed daily when in use to be sure that the sight is ready at all times. Procedures listed in Table 4-1 are a systematic inspection of OTS that will enable you to discover defects that might cause the sight to fail on a mission.

4.1.2. FREQUENCY OF PERFORMING PMCS

The frequency of performing PMCS is as follows:

- A. Daily when the sight is in use.
- B. When it is removed from the case for any reason.

Table 4-1. Preventive Maintenance Checks and Services

SEQ. NO.	ITEM TO CHECK	CHECKING PROCEDURE	NOT FULLY MISSION CAPABLE IF:
1	Completeness	Inventory items by means of comparing with the data specified in this manual.	Items missing.
2	Sight Body	Inspect for missing screws or connector cap.	Screws or connector cap missing.
3	Front Lens Cap	Inspect for cuts, tears and dirt. Clean as required.	Cap torn or cut.
4	Battery Compartment	Check for corrosion, springs tension, cap damaged or retainer broken. Check O-ring for cuts or damage.	Springs corroded or damaged. Retainer broken. Cap or O-ring damaged or missing.
5	Function Switch	Check for operation (without battery).	Switch inoperative. Knob missing.

SEQ. NO.	ITEM TO CHECK	CHECKING PROCEDURE	NOT FULLY MISSION CAPABLE IF:
6	Lenses	Inspect for cleanliness, scratches, chips or cracks. Clean as required.	Chipped, cracked or if scratches hinder vision through the sight.
7	Objective Lens	Check to ensure the objective lens is not loose.	Objective lens loose.
8	Focus Ring	Check to ensure: - the focus ring cannot be moved along the sight body; - there is free rotation of the focus ring (more than 3/4 turn).	Focus ring able to move along sight body. Focus ring cannot be rotate.
9	Rubber Eye-cup	Inspect for cuts or tears.	Rubber Eye-cup torn or cut.
AFTER CHECKING PROCEDURES			
10		Replace protective covers on the lenses. Remove the battery. Return the scope and all accessories to the storage case.	

4.2. TROUBLESHOOTING

4.2.1. GENERAL

This section contains information for locating and removal most of the OTS operating troubles which may occur. Each malfunction for an individual component or assembly is followed by a list of tests or inspections that will help determine probable causes and corrective action to take. Perform the tests/inspections and corrective actions in the order listed.

This manual cannot list all possible malfunctions that may occur, or all tests or inspections and corrective actions. If a malfunction is not listed (except when malfunction and cause are obvious), or is not corrected by listed corrective actions, contact to the service center.

4.3.2. TROUBLESHOOTING PROCEDURES

Troubleshooting procedures are listed in Table 4-2.

Table 4-2. Troubleshooting Procedures

PROBLEM	PROBABLE CAUSE	CORRECTIVE ACTION
Image is absent	Battery is missing or improperly installed.	Insert battery or install correctly.
	Battery is dead.	Replace battery.
	Battery contact surfaces or contact springs dirty or corroded.	Clean the contact surfaces with a pencil eraser and/or alcohol and cotton swabs.
Cannot achieve the sharp image of the object.	Objective and output lenses dirty.	Clean thoroughly the lenses surfaces.
	Damaged optical components.	Send the sight to the service center.
The brightness of the image on the screen is low.	The batteries has a low voltage.	Replace the batteries.
	Factory alignment broken.	Send the scope to the service center.

4.3. MAINTENANCE PROCEDURES

4.3.1. SCOPE MAINTENANCE

The OTS maintenance consists of external inspection of its components for serviceability, cleaning and installation of the standard and optional accessories. Maintenance instructions covered elsewhere in this manual (PMCS, troubleshooting, etc.) are not repeated in this section.

CAUTION

The OTS is a precision electron-optical instrument and must be handled carefully at all times to prevent damage.

4.3.2. CLEANING PROCEDURES

A. Cleaning the scope

1. Gently brush off any dirt from the sight body using only a clean soft cloth.
2. Moisten the cloth with fresh water and gently wipe the external surfaces (except lenses).
3. Dry any wet surfaces (except lenses) with another dry and clean soft cloth.
4. Using lens brush, carefully remove all loose dirt from the lenses.
5. Slightly dampen a cotton swab with ethanol and lightly and slowly wipe the lenses. Clean the glass surfaces by circular movements from the centre to the edge, not touching the lens holder and changing cotton swab after each circular stroke. Repeat this step until the glass surfaces are clean.

B. Cleaning of accessories

Clean accessories with a soft brush (cloth) and soap and water as required.

CAUTION

Dry thoroughly each item before replacing into the storage case.

4.3.3. PREPARING FOR EXTENDED STORAGE

To prepare the OTS for extended storage, perform the following:

1. Check the monocular for serviceability as outlined in item 4.1 of this manual.
2. Remove the batteries.
3. Clean the monocular and accessories.
4. Replace all items in the case.

4.3.4. HEADMOUNT MAINTENANCE

A. REMOVAL AND INSTALLATION OF BROWPAD

1. Remove old browpad (Figure 4-1) by grasping the headband.
2. Replace the browpad by gently pressing on the new browpad and smoothing out any wrinkles in new browpad.



Figure 4-1. Removal and Installation of Browpad

B. REMOVAL AND INSTALLATION OF CHINSTRAP

1. Remove the chinstrap (Figure 4-2) by unsnapping the Welcro tape from the left side of the headband. Unbuckle the chinstraps from narrow strap assembly.
2. Replace the chinstrap by using the Welcro tape on the left side of the headband. Lace the right straps into their respective sliding bar buckles on the right side of the headband for correct lacing (Figure 4-2).

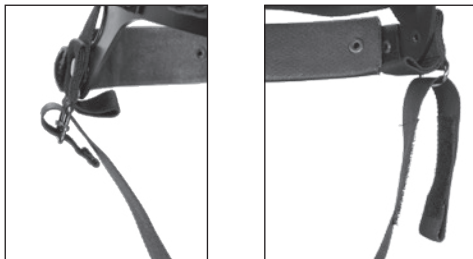

Figure 4-2. Removal and Installation of Chinstrap

C. REMOVAL AND INSTALLATION OF CHIN CUP

1. Remove the chinstrap (Figure 4-3) by unsnapping the Welcro tape from the left side of the headband.
2. Replace the chin cup by sliding the cap on the chinstrap. Fix the Welcro tape onto the place.



Figure 4-3. Removal and Installation of Chin Cup

APPENDIX A

SPARE PARTS LIST

The Spare Parts List is an illustrated catalog of main parts and assemblies completing the OTS system.

Therefore, in case of failure of any part or assembly User could replace it by ordering the corresponding part/assembly from the Spare Parts List. The amount and assortment of the spare parts needed should be arranged with each contract individually.

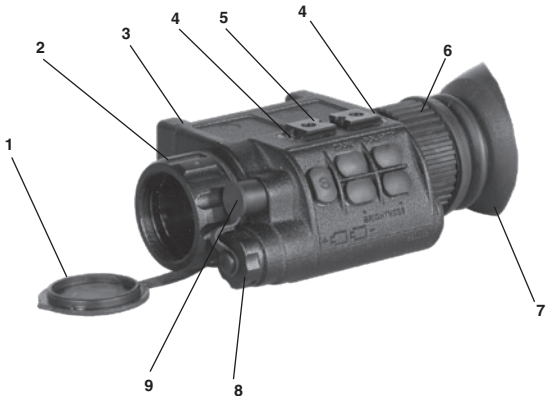

Figure A-1. OTS Scope

Table A-1. OTS14 spare parts list

PART NO.	DESCRIPTION	FIG	ITEM	QTY
AT 88831.000	Scope	A1		
AT 88831.001	Lens Cap	A1	1	1
AT 88831.002	Focusing Ring	A1	2	1
AT 88831.003	Housing	A1	3	1

PART NO.	DESCRIPTION	FIG	ITEM	QTY
AT 88831.004	Screw	A1	4	4
AT 88831.005	Rail	A1	5	2
AT 88831.006	Eye Piece	A1	6	1
AT 88831.007	Rubber Eye-cup	A1	7	1
AT 88831.008	Battery Cap	A1	8	1
AT 88831.009	Connector Cap	A1	9	1
AT 88831.010	CR123A type battery	A1	10	1



Figure A-2. OTS-14 Accessories

Table A-2. OTS14 Accessories parts list

PART NO.	DESCRIPTION	FIG	ITEM	QTY
	Accessories 1	A2		
AT 88832.000	Soft Case	A2	1	1
AT 88833.000	RCA Video/power adapter	A2	2	1
AT 88834.000	Storage Case	A2	3	1
AT 88836.000	Neck Lanyard	A2	4	1
AT 88837.000	Operator's Manual	A2	5	1
AT 88838.000	Lens Tissue	A2	6	1

PART NO.	DESCRIPTION	FIG	ITEM	QTY
AT 88839.000	Flip-up Helmet Mount	A2	7	1
AT 88840.000	Headmount Assembly	A2	8	1
AT 88841.000	Dual Bridge	A2	9	1
AT 88843.000	Afocal 2X Lens	A2	11	1



Figure A-3. Headset Assembly

Table A-3. Headset Assembly

PART NO.	DESCRIPTION	FIG	ITEM	QTY
AT 88840.0001	Screw	A4	1	1
AT 88840.0002	Mount Assembly	A4	2	1
AT 88840.0003	Headset	A3	3	1
AT 88840.0004	Chinstrap	A4	4	1
AT 88840.0005	Headpad	A4	5	1

PART NO.	DESCRIPTION	FIG	ITEM	QTY
AT 88840.0006	Browpad	A4	6	1
AT 88840.0007	Chin Cup	A4	7	1



Figure A-4. Helmet Mount Assembly

Table A-4. Helmet Mount Assembly

PART NO.	DESCRIPTION	FIG	ITEM	QTY
AT 88839.0001	Screw	A5	1	1
AT 88839.0002	Mount Assembly	A5	2	1



For customer service and
technical support, please contact
American Technologies Network Corp.

North American Office:

1341 San Mateo Avenue
South San Francisco, CA 94080

phone: 800-910-2862, 650-989-5100

fax: 650-875-0129

info@atncorp.com

www.atncorp.com